

## R-ZS-3000 "30-Inch Radial Large Single Apron"

### Features

- Certified 304 Grade 18 Gauge Stainless Steel
- Single Compartment
- 6-1/2" Front Apron Design
- Fits into most standard cabinets with no cutting
- 20° Inside Corner Rounded "Radial" Bowls for Easier Cleaning
- Unique sound-deadening system with sound pads and a special coating
- Lustrous and enduring finish which compliments any decor
- Limited lifetime warranty

### Front Apron Kitchen



--- Dimensions ---	
Outer:	30" x 21-7/8" x 9"
Inner:	26" x 17" x 9"

Model	Description	Construction Material
R-ZS-3000 "30-Inch Radial Large Single Apron"	Apron Sink	Stainless Steel

### Included Components

- Cut-out template

### Colors / Finishes

- Brushed Stainless Finish

### Optional Accessories

- Standard Strainer
- Premium Strainer
- Sink Grids

### Codes / Standards Applicable

Specified model meets or exceeds the following:

- Warnock Hersey Certified
- CSA Certified



### Product Specification

This sink shall be a Front-Apron style single compartment featuring 20° inside rounded corner bowls. It shall be 30" in length and 21-7/8" in width, with a bowl depth of 9". Sink shall be made of 18 gauge stainless steel. Sink shall include installation hardware. Sink shall be UrbanPlace Model R-ZS-3000 "30-Inch Radial Large Single Apron".

# R-ZS-3000 "30-Inch Radial Large Single Apron"

## TECHNICAL INFORMATION

-- Fixture -- *	
Basin Area	26" x 17" x 9"
Drain Hole Diameter	3-5/8"
*Approximate measurements for comparison only.	



Product Image

Side View

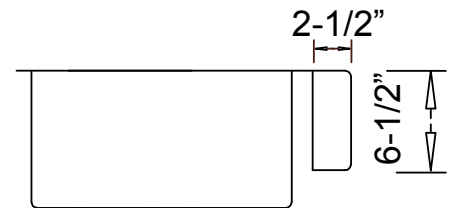

Front View

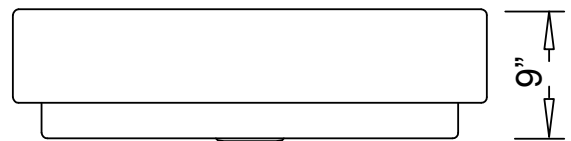

Top View

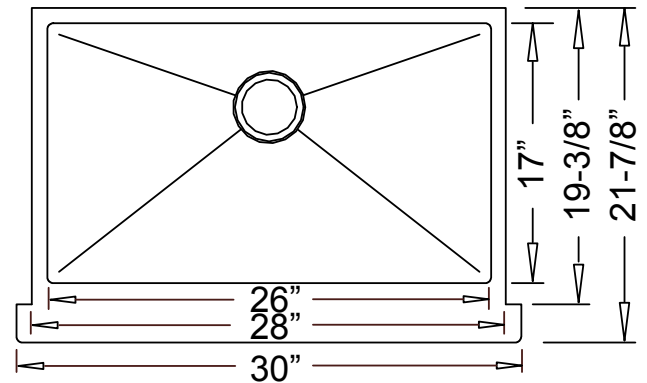

Product Diagram