

RG46UM

Features

- Certified 304 Grade 15 Gauge Surgical Stainless Steel.
- Undermount Design.
- Single Compartment.
- Rectangular Bowl.
- Ledge near top of sink where most included accessories sit.
- Lustrous and enduring finish which compliments any decor.
- Limited lifetime warranty.

Undermount Kitchen



--- Dimensions ---	
Outer:	46" x 19-1/2" x 10"
Inner:	44" x 17" x 10"

Model	Description	Colors / Finishes
RG46UM	Undermount Sink	N/A

Included Components

- Cutting Board (Sits on top of sink, reveal cutout required)
- Roll-Up Dish Rack (Sits in ledge)
- Colander (Sits in ledge)
- Grid
- Strainer
- Installation Template
- Mounting Clips

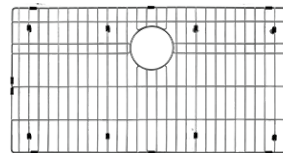
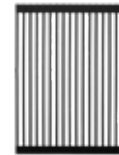

Optional Accessories

- Cutting Board with Bow (CB-011, CB-011-BWL)
(Sits in Ledge, Board and Bowl Sold Separately)
- Cutting Board (CB-012)
(Sits on top of sink, reveal cutout required)



CB-011, CB-011-BWL



CB-012

Colors / Finishes

- N/A None Applicable

Codes / Standards Applicable

Specified model meets or exceeds the following:

- UPC Certified



Product Specification

This Undermount sink shall be a single compartment with rectangular bowl. It shall be 46" in length and 19-1/2" in width, with a depth of 10". It shall feature a ledge near the top of the sink where most included accessories sit.

Sink shall be made of 15 Gauge Stainless Steel. Sink shall be Ridge Model RG46UM.

TECHNICAL INFORMATION

Fixture*	
Overall Inner Area	44" x 17"
Water Depth	10"
Drain Hole	3-5/8" D
*Approximate measurements for comparison only.	



Product Image

Front View

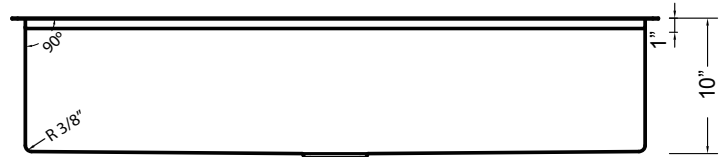

Top View

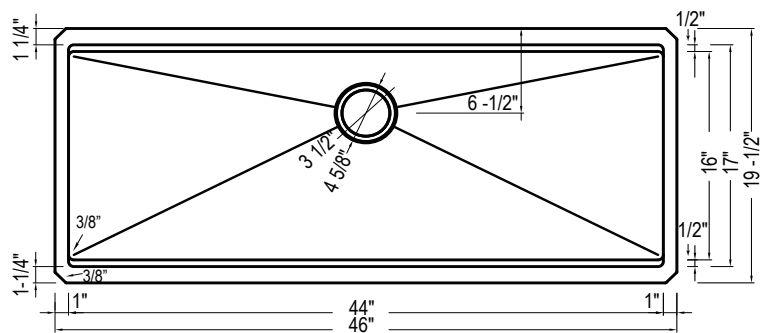

Product Diagram