

R-ZS-3500

Features

- Certified 304 Grade 18 Gauge Stainless Steel
- Single Compartment
- 6-1/2" Front Apron Design
- Fits into most standard cabinets with no cutting
- R15mm rounded "Radial" inside corners for Easier Cleaning
- Unique sound-deadening system with sound pads and a special coating
- Lustrous and enduring finish which compliments any decor
- Limited lifetime warranty

Front Apron Kitchen



--- Dimensions ---	
Outer:	35" x 21-7/8" x 9"
Inner:	31" x 17" x 9"

Model	Description	Construction Material
R-ZS-3500	Apron Sink	Stainless Steel

Included Components

- Cut-out template
- Grid
- LI-XD Strainer

Colors / Finishes

- Brushed Stainless Finish

Codes / Standards Applicable

Specified model meets or exceeds the following:

- Warnock Hersey Certified
- CSA Certified



Product Specification

This sink shall be a Front-Apron style single compartment featuring R15mm rounded "Radial" inside corner bowl. It shall be 35" in length and 21-7/8" in width, with a bowl depth of 9". Sink shall be made of 18 gauge stainless steel. Sink shall include installation hardware, Grid, and LI-XD Strainer. Sink shall be UrbanPlace Model R-ZS-3500.

TECHNICAL INFORMATION

-- Fixture -- *	
Basin Area	31" x 17" x 9"
Drain Hole Diameter	3-5/8"
*Approximate measurements for comparison only.	



Product Image

Side View

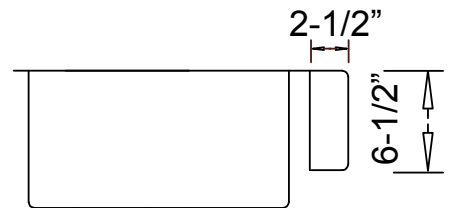

Front View

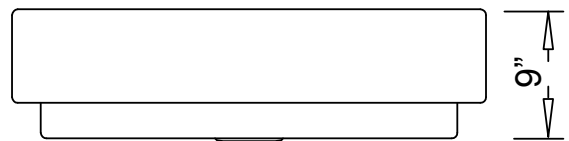

Top View

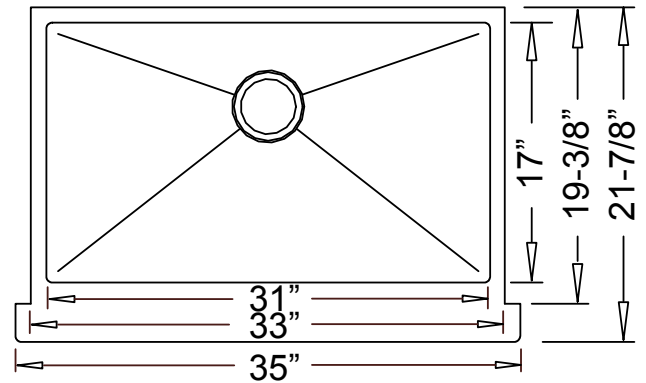

Product Diagram