



Polished Chrome

The integrity of solid brass plated in highly polished chrome for a stunning mirror smooth finish lends authenticity to modern retro designs and futuristic high tech settings.

Satin Nickel

The perfect design solution for applications when both silver tones and an aura of understated sophistication are needed.



Description

- Pull-Out Kitchen Faucet
- Three Holes Mount, Fit 1-3/8" to 2" Hole
- 35mm Ceramic Cartridge (NTK Ceramic Disc)
- Switches Spray/Stream Aerator
- 180° Swivel Spout, Two Check Valve Include
- Metal Lever Handle (Option Loop Handle)
- 3/8" * 12" S.S. C/H Braided Supply Hose
- 60" Length Pull-Out S.S. Flexible Hose
- Quick Mount Locking Nut Mechanism
- 1/2" IPS Connector

Model:
WL-K-110010-ZZ

Compliance

- Complies with the requirements of CUPC
- Complies with NSF
- Complies with AB1953
- Complies with ASME

Warranty

- Limited Lifetime Warranty

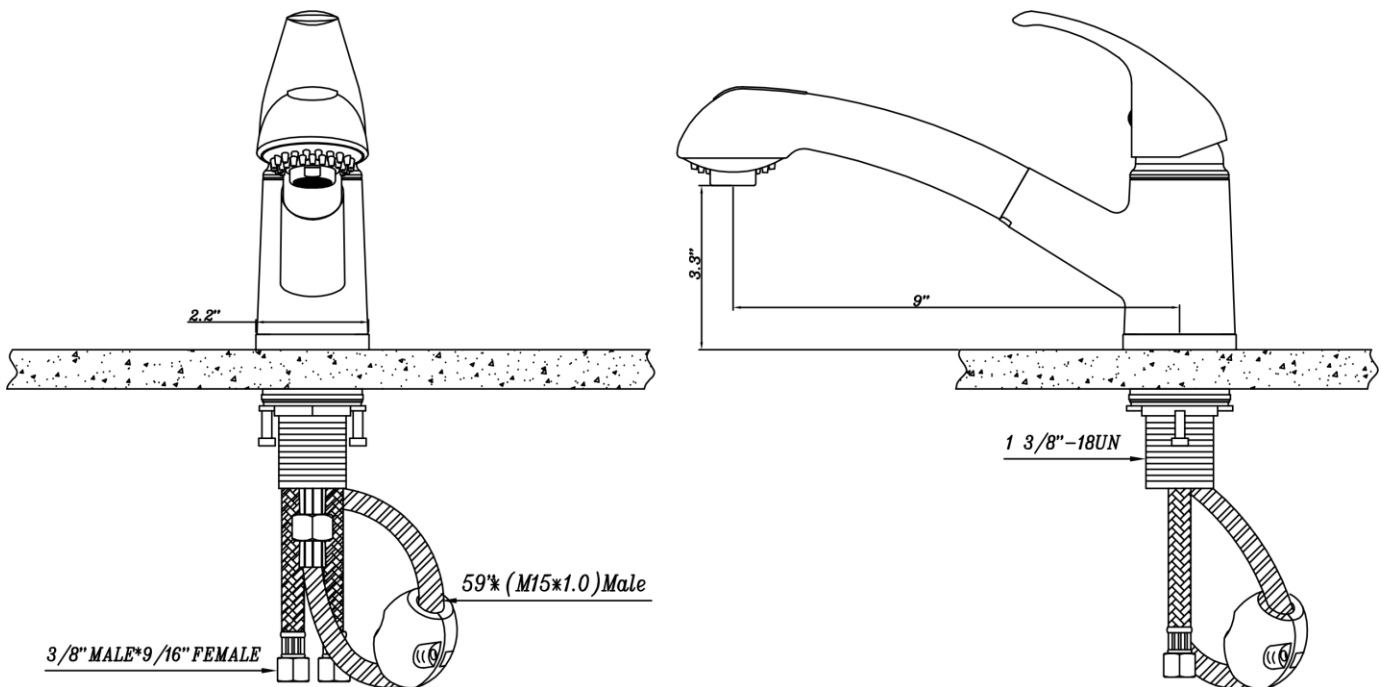

Kitchen Pull-Out



Model: WL-K-110010-ZZ

Available Finishes

- Chrome (CP)
- Satin Nickel (SN)
- Oil Robbed Bronze (ORB)

Standards



- IAPMO UPC/CUPC
- NSF 61-9



- ASME A112.18.1



- CAAB-1953



- ADA Accessibility Guidelines

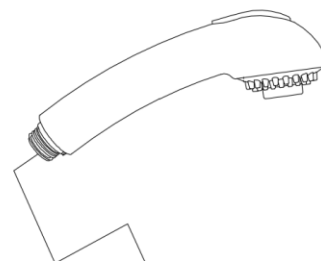
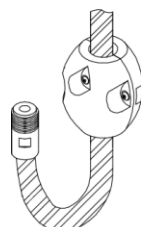
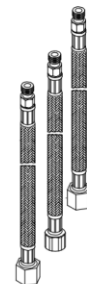
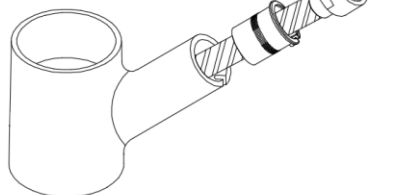
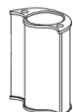
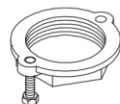
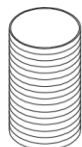
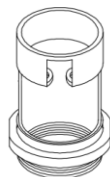

Instruction Sheet

Please read carefully before installation.



Model Number:

WL-K-110010-CP

WL-K-110010-SN

INSTALLATION STEPS: INSTRUCTIONS POUR LE MONTAGE:

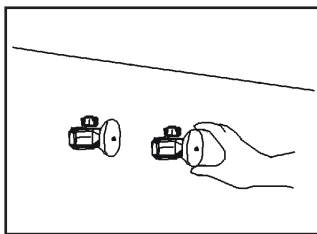

1. Shut off water supply.
Remove old faucet.
Clean sink surface in
preparation for new faucet

Fermer l'alimentation en eau.
Enlever le vieux robinet.
Nettoyer la surface du lavabo
en prevision de l'installation
du robinet neuf.

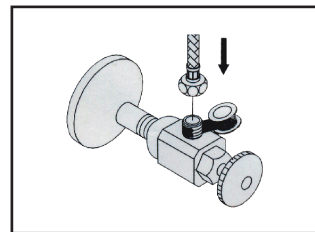

5. Apply pipe tape onto
of the water supply.

Appliquer du rubon pour
tuyau sur les filets de
l'alimentation d'eau.

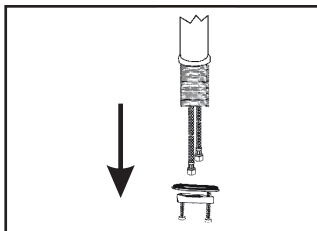

2. Remove rubber washer,
metal washer and lock
nut from brass shank.

Retirer rondelle en
caoutchouc, métal machine
à laver et un contre-écrou de
tige de laiton.

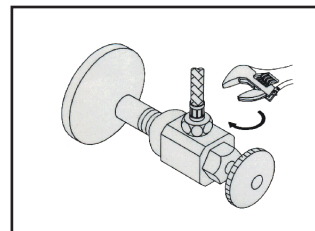

6. Tighten the hose onto
water supply.

Visser le boyau sur la
conduite d'alimentation
d'eau.

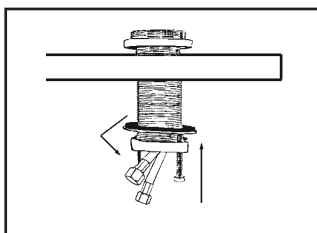

3. Position new faucet. Attach
rubber seal, metal washer,
and lock nut on mounting
body. Tighten the two screws
on lock nut.

Mettre le nouveau robinet en
place. Fixer la rondelle étanche,
la rondelle de métal et l'écrou de
blocage au corps. Serrer les deux
vis de l'écrou de blocage.

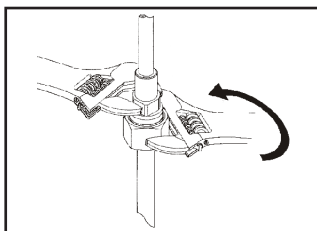

4. Attach water supply hose to the
faucet. Tighten end of shank
with wrench and slip hose onto
inlet port.

Joindre l'approvisionnement en
eau tuyau au robinet. Serrer
l'extrémité de la tige à l'aide de
la clé et glisser boyau sur l'orifice
d'entrée.

Maintenance: Your new faucet is designed for years of trouble-free performance. Keep it looking new by cleaning it periodically with a soft cloth. Avoid abrasive cleaners, steel wool and harsh chemicals as these will dull the finish and void your warranty.

Entretien: Votre nouveau robinet est conçu pour fonctionner sans problèmes, des années durant. Le nettoyer périodiquement avec un chiffon doux pour qu'il conserve la même apparence qu'à l'état neuf. Éviter les nettoyeurs abrasifs, la laine d'acier et les produits chimiques forts puisqu'ils endommageront le fini et rendront votre garantie nulle.